

キャンパスマップ

瓜生山キャンパス

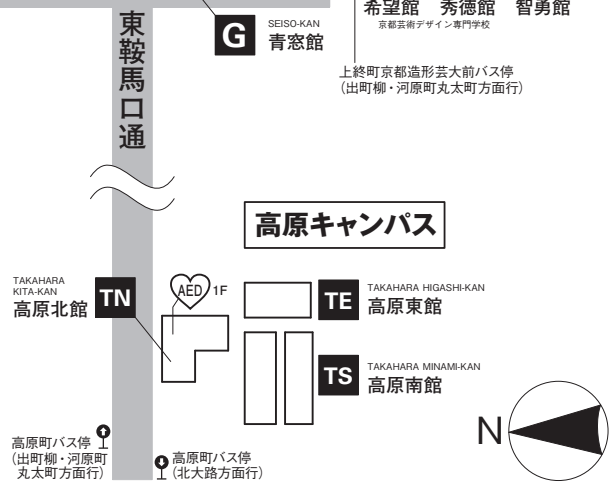
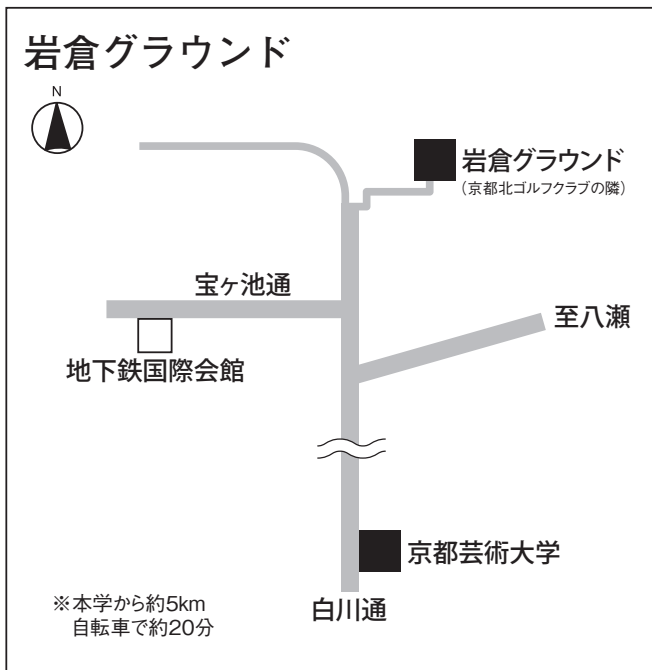
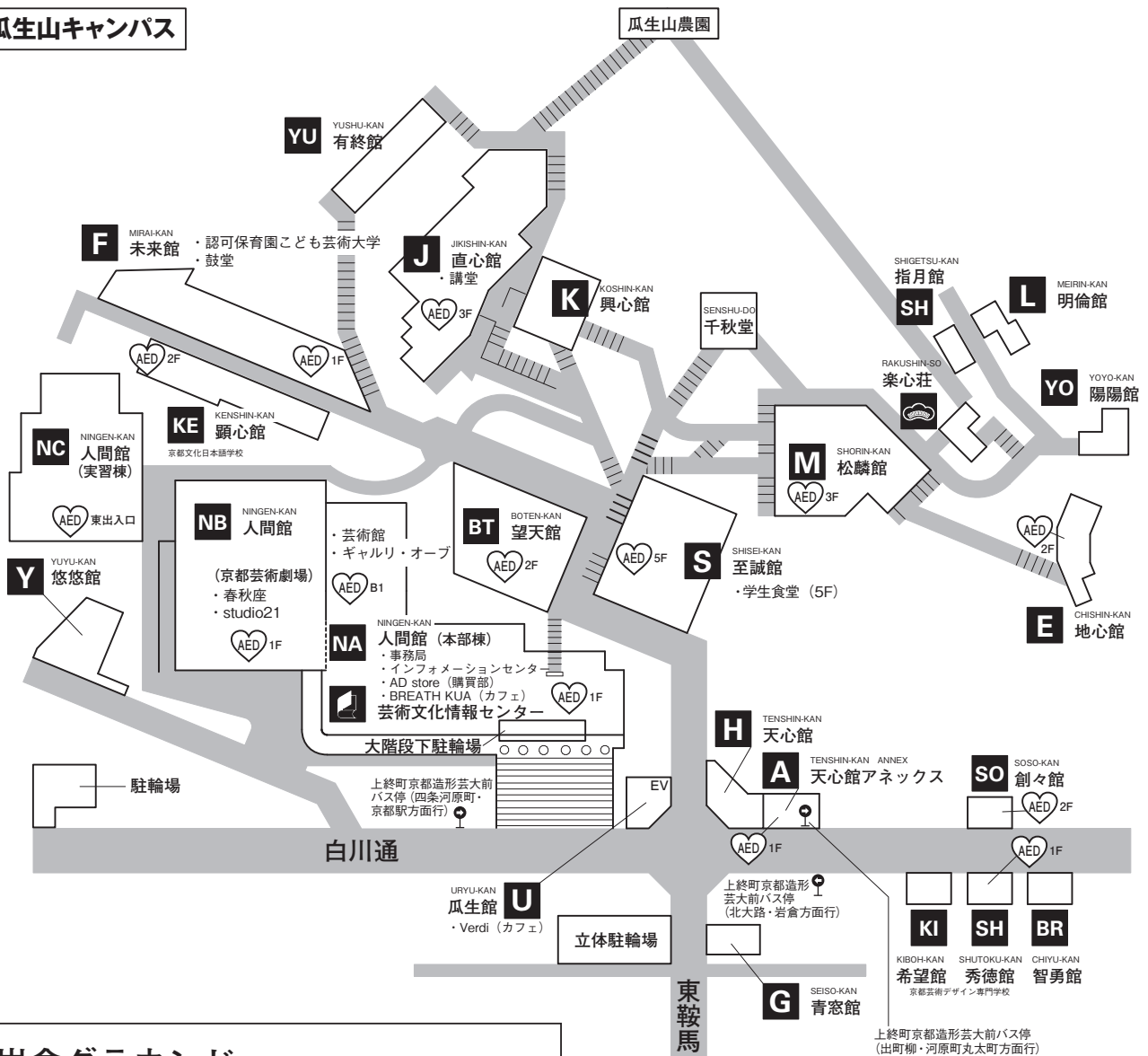

AED AED設置場所

AED: Automated External Defibrillator
(自動体外式除細動器)

校舎・教室配置図

NA 人間館 (本部棟)

NB 人間館 (京都芸術劇場)

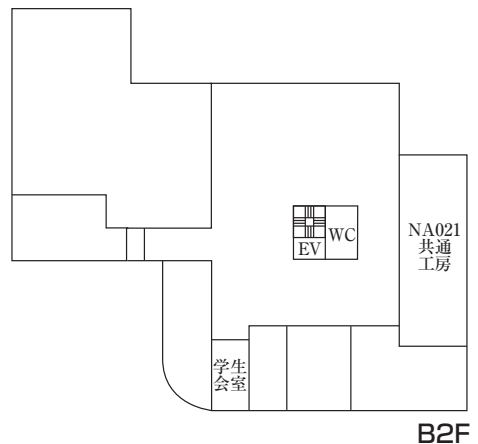
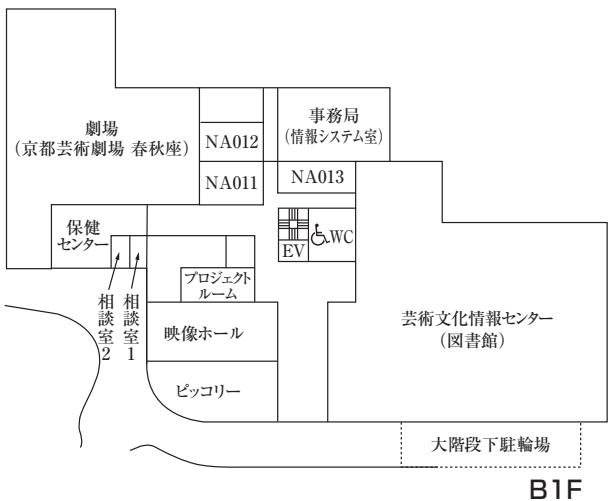
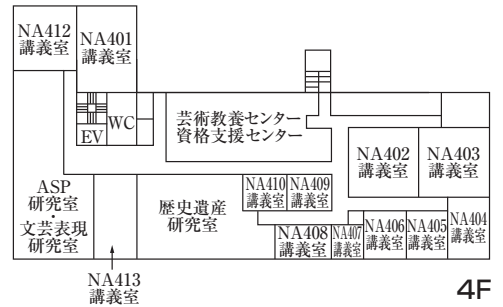
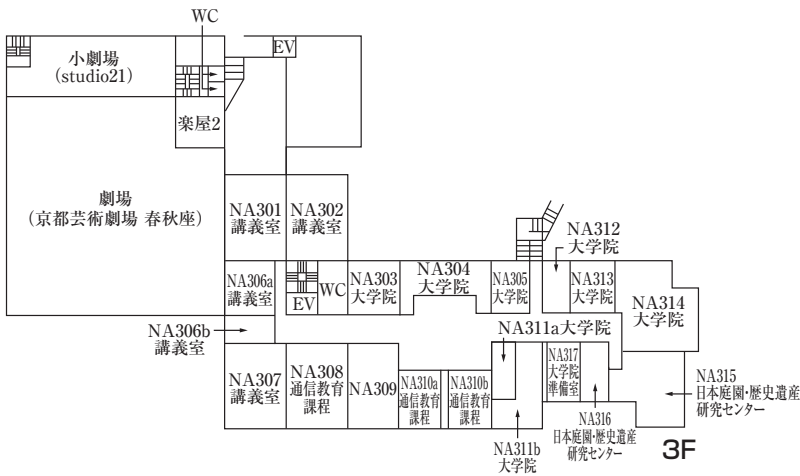
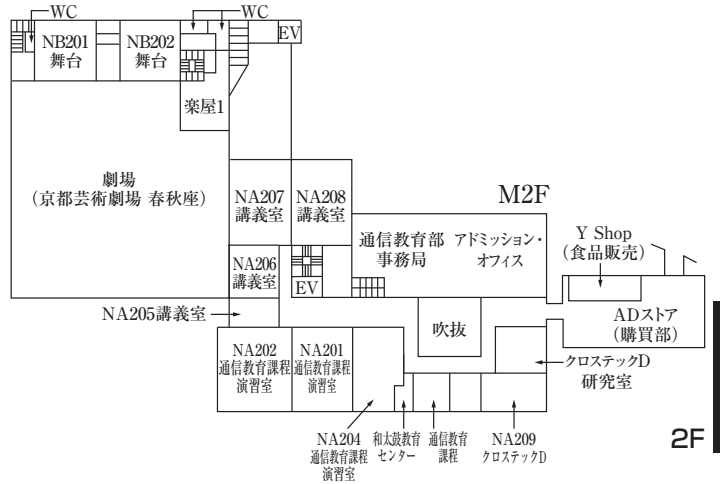
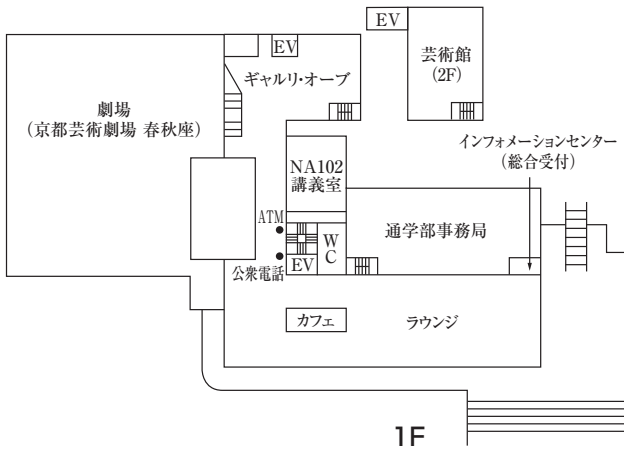

参考資料

キャンパスマップ/校舎・教室配置図

NC 人間館 (実習棟)



Y 悠悠館

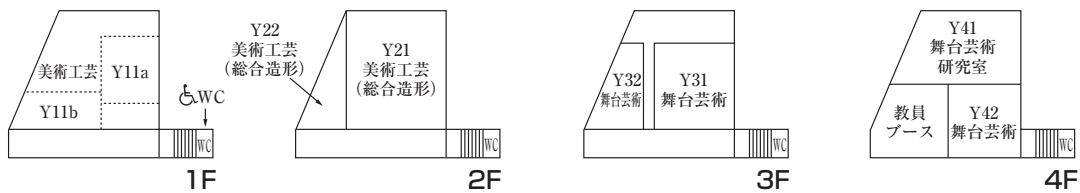

G 青窓館

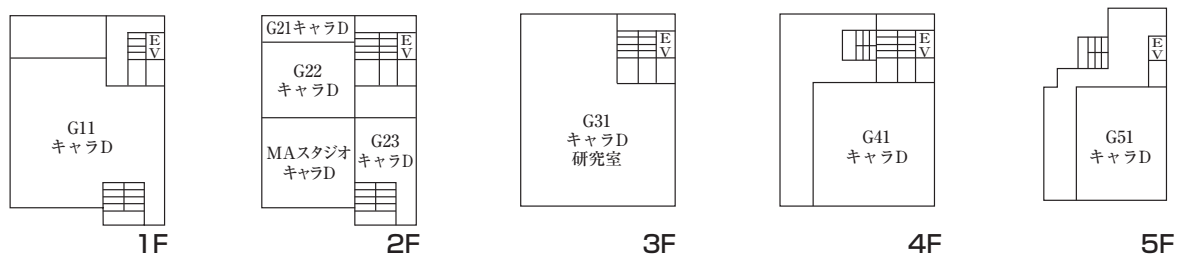

H 天心館 **A 天心館アネックス**

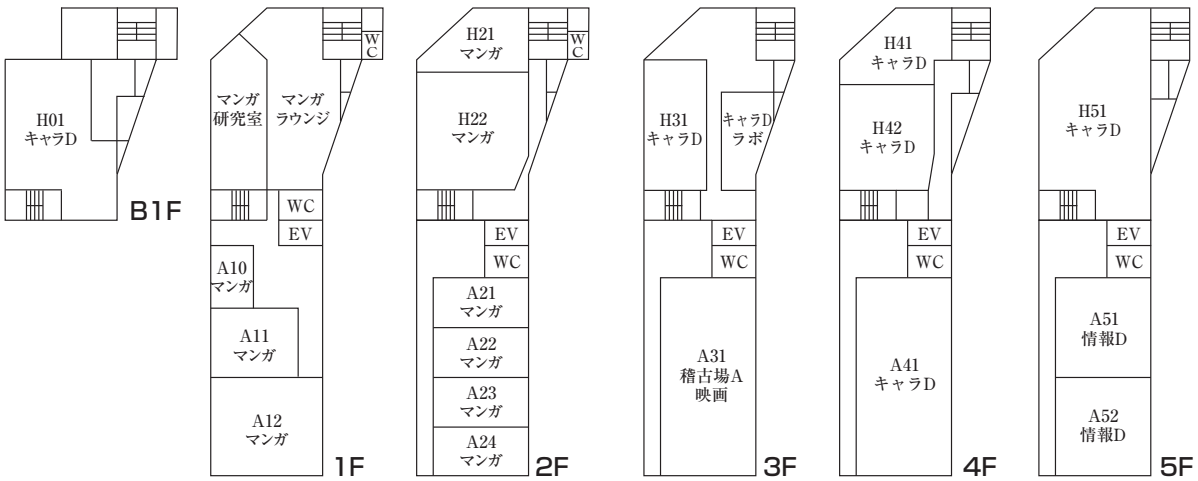

BR 智勇館

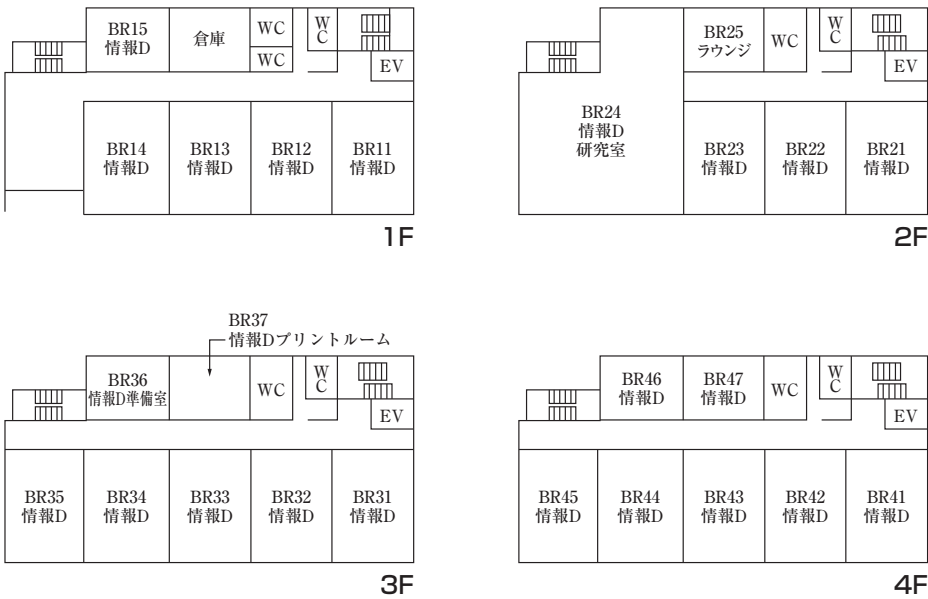

SO 創々館

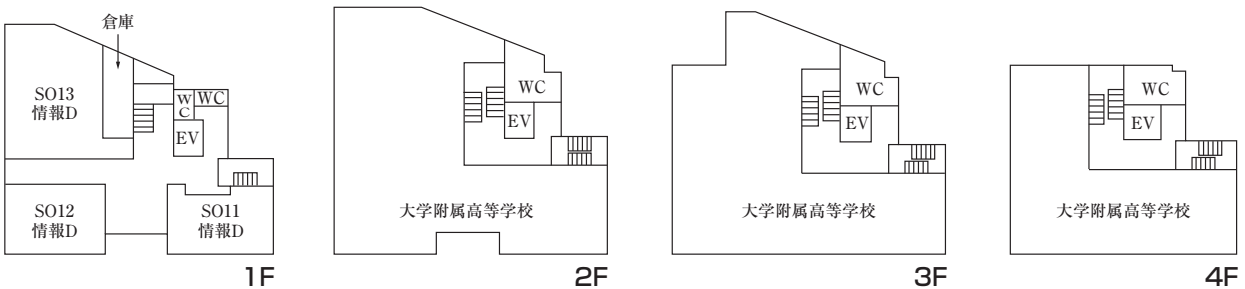

J 直心館 **K 興心館**



1F

K11 空間演出D
研究室

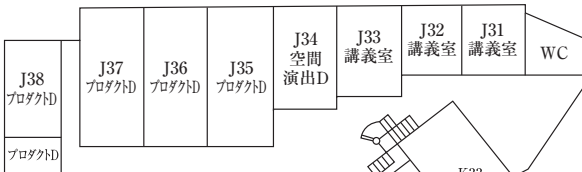

3F

通信
教育部



2F

K21 空間演出D

K22 空間演出D
研究室



4F

K41 講義室
共通デッサン室
創学

M 松麟館

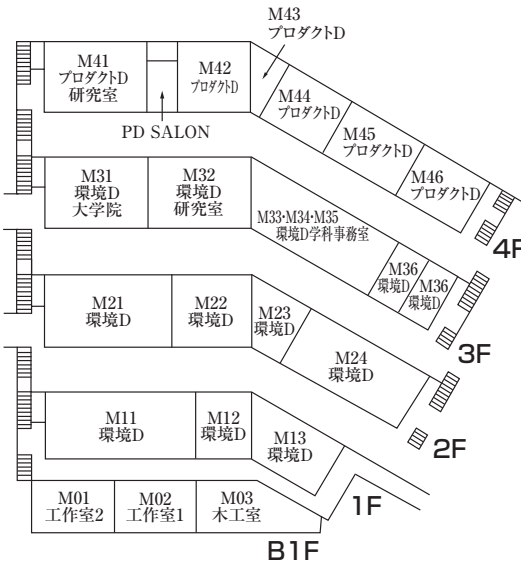

YU 有終館 (クラブボックス)

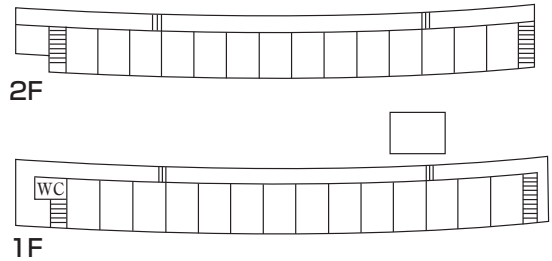

YO 陽陽館

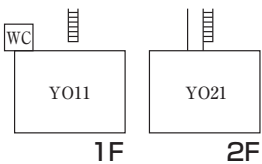

千秋堂

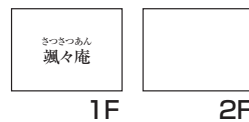

楽心荘

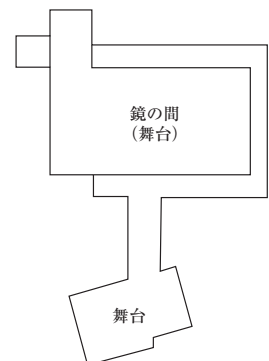

E 地心館

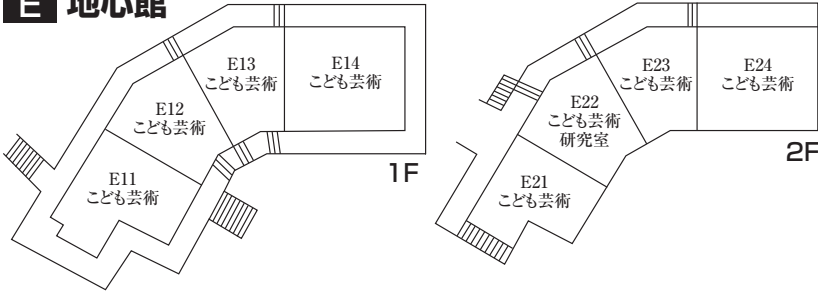

S 至誠館

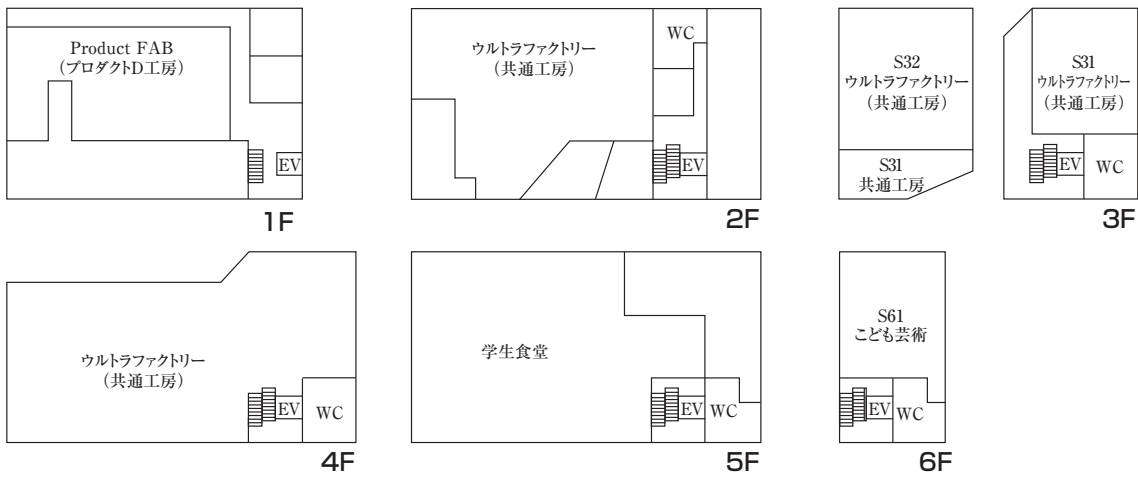

F 未来館

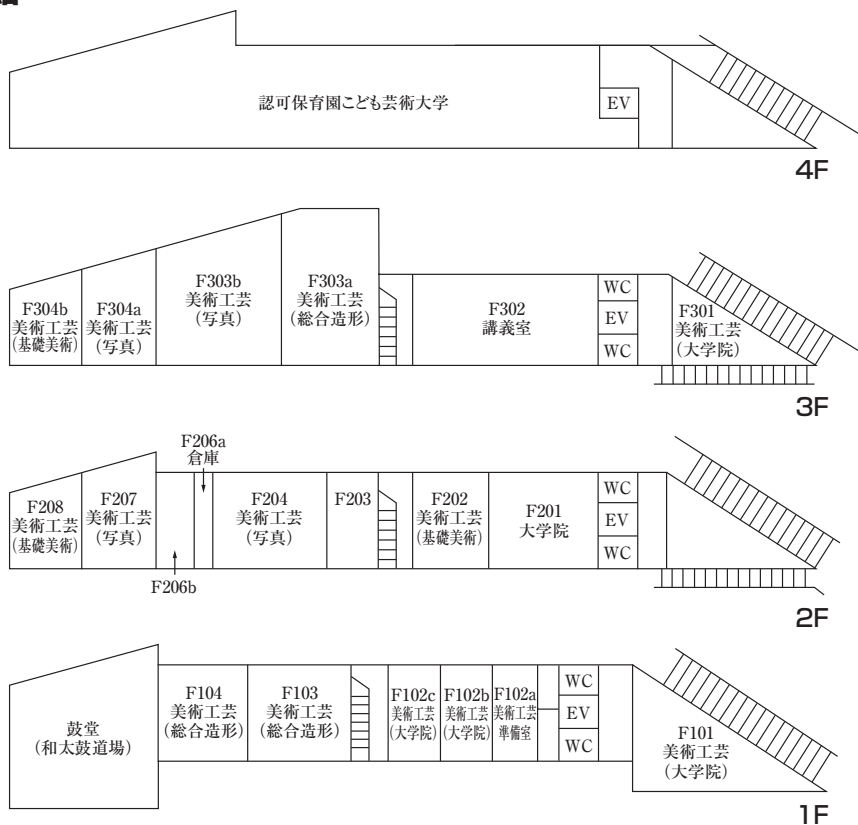

TN 高原北館

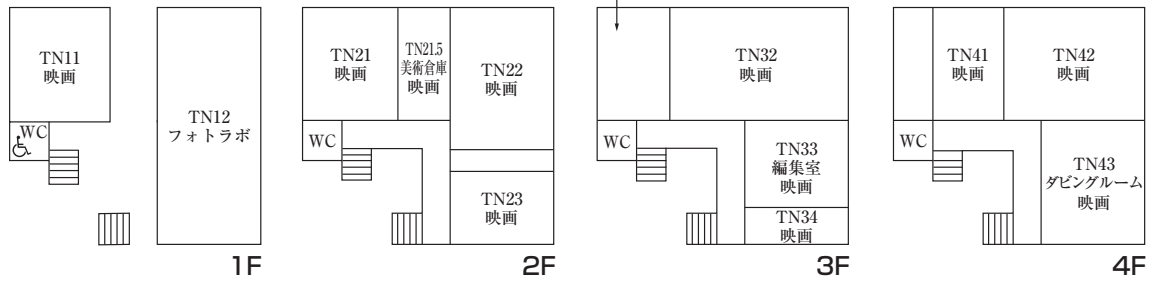

TS 高原南館・TE 高原東館

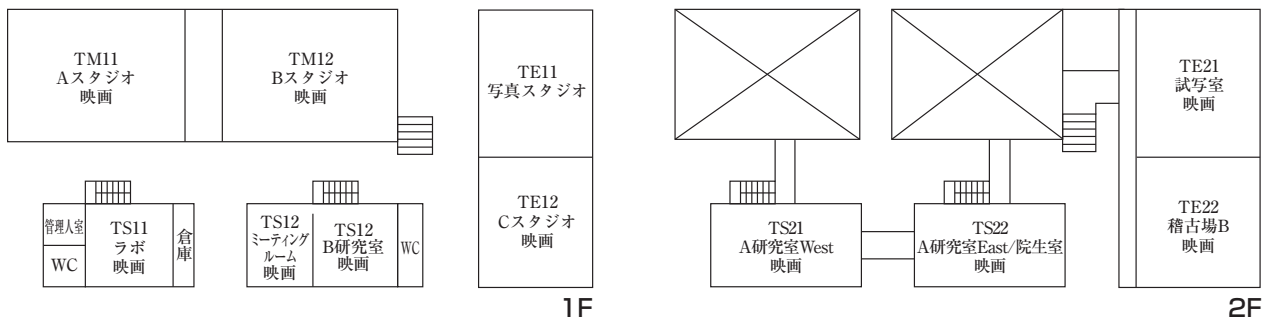

BT 望天館

